

X 2  
**IP 55**  
X 2

	<ul style="list-style-type: none"> <li>• 240 V~</li> <li>• 240 B~</li> <li>• 240 Volt</li> </ul>		<ul style="list-style-type: none"> <li>• Max.</li> <li>• Máx.</li> <li>• Макс.</li> <li>• Maks.</li> <li>• Maksimum</li> <li>• 최대</li> </ul>
	<ul style="list-style-type: none"> <li>• 50 / 60 Hz</li> <li>• 50 / 60 Гц</li> </ul>		<ul style="list-style-type: none"> <li>• Min.</li> <li>• Mín.</li> <li>• Мин.</li> <li>• Min.</li> <li>• Minimum</li> <li>• 최소</li> </ul>
	<ul style="list-style-type: none"> <li>• 1 x 2,5 mm<sup>2</sup> – 2x1,5mm<sup>2</sup></li> <li>• 1 x 2,5 mm<sup>2</sup> – 2x1,5mm<sup>2</sup></li> </ul>		
	<ul style="list-style-type: none"> <li>• PIR</li> <li>• IV</li> <li>• IR</li> <li>• Passive Infra Red (PIR)</li> <li>• PIR (인체감지)</li> </ul>		<ul style="list-style-type: none"> <li>• 8 m</li> <li>• 8 m</li> <li>• 8 meter</li> </ul>

<ul style="list-style-type: none"> <li>• 230 V~</li> <li>• 230 B~</li> <li>• 230 Volt</li> </ul>	<ul style="list-style-type: none"> <li>• 1000 W</li> <li>• 1000 Br</li> </ul>	• 4,3 A	<ul style="list-style-type: none"> <li>• 500 VA</li> <li>• 500 BA</li> </ul>	• 2,1 A	<ul style="list-style-type: none"> <li>• 5 x (2x36 W)</li> <li>• 5 x (2x36 Br)</li> </ul>	• 2,1 A	<ul style="list-style-type: none"> <li>• 250 VA</li> <li>• 250 BA</li> </ul>	• 1,1 A	<ul style="list-style-type: none"> <li>• 500 VA</li> <li>• 500 BA</li> </ul>	• 2,1 A

<ul style="list-style-type: none"> <li>• 230 V~</li> <li>• 230 B~</li> <li>• 230 Volt</li> </ul>	<ul style="list-style-type: none"> <li>• 5 x (2x36 W)</li> <li>• 5 x (2x36 Br)</li> </ul>	• 2,1 A	<ul style="list-style-type: none"> <li>• 250 W</li> <li>• 250 Br</li> </ul>	• 1,1 A	<ul style="list-style-type: none"> <li>• 250 VA</li> <li>• 250 BA</li> </ul>	• 1,1 A	<ul style="list-style-type: none"> <li>• 250 VA</li> <li>• 250 BA</li> </ul>	• 1,1 A	<ul style="list-style-type: none"> <li>• 250 W</li> <li>• 250 Br</li> </ul>	• 1,1 A

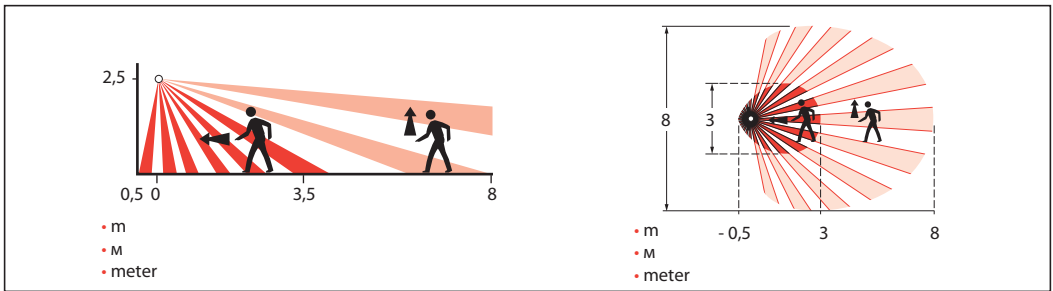

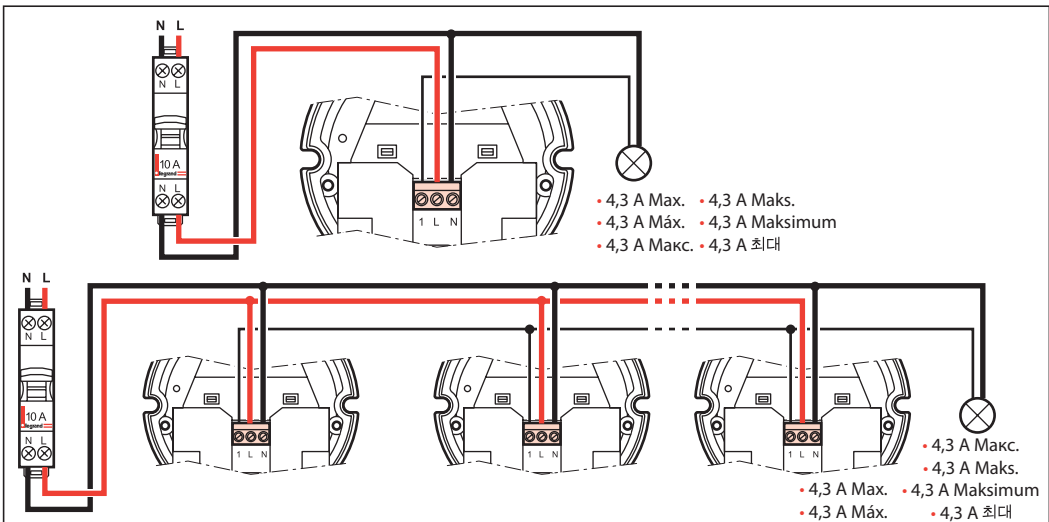
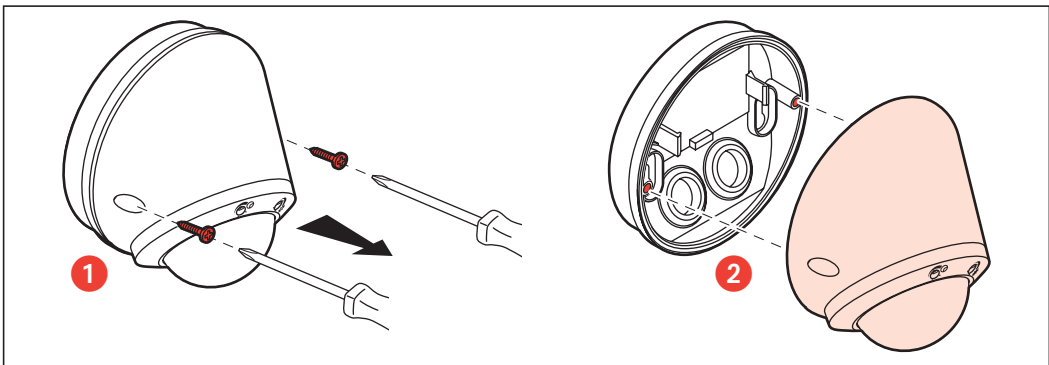
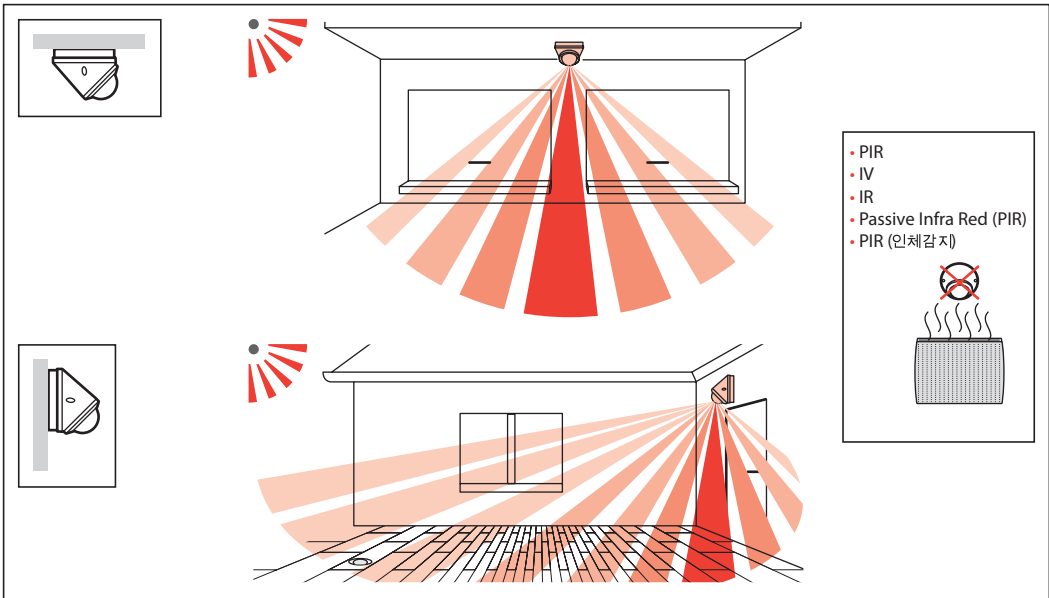

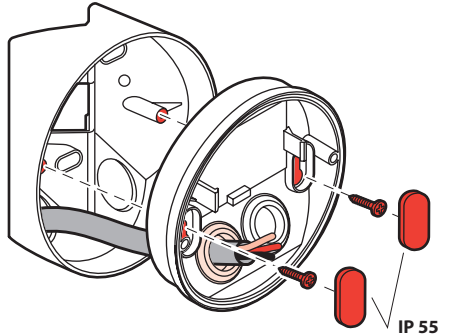
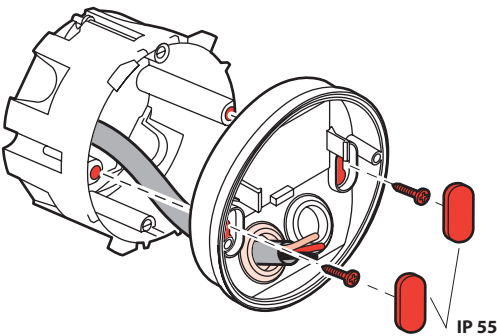
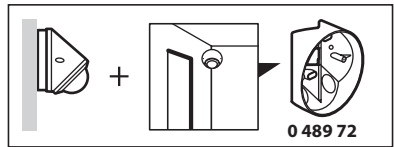
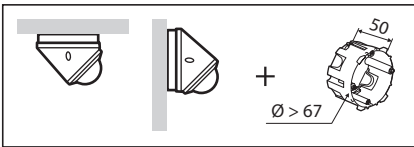
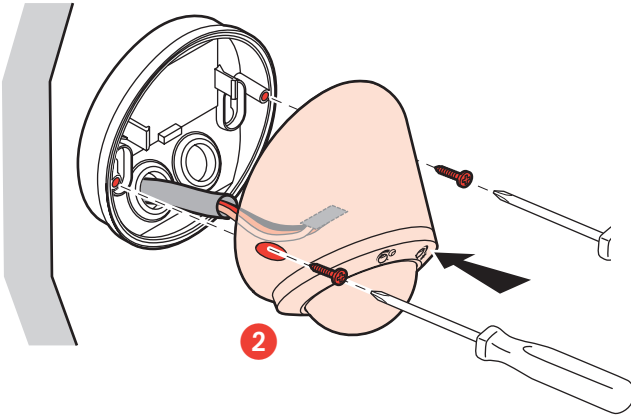
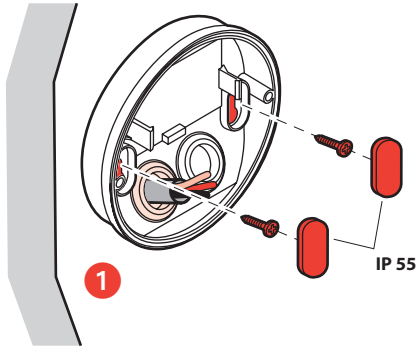
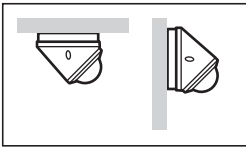



• Mode Auto  
• Modo Auto

• Режим авто  
• Tryb Auto

• Mod oto  
• Mód Auto

• الوضع -اتوماتيكي  
• Mod Auto

• 모드 자동

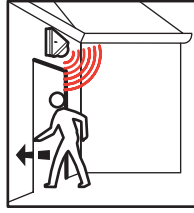
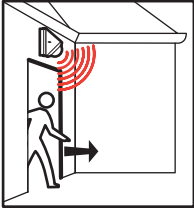

**i** [www.legrandoc.com](http://www.legrandoc.com)

- Potentiomètre de luminosité
- Regeling lichtsterkte
- Daylight setpoint
- Helligkeitseinstellung
- Regulador de luz
- Ajuste da sensibilidade luminosa
- Ρύθμιση φωτεινότητας
- Потенциометр регулировки порога освещенности
- Ustawienie progu oświetlenia
- Gün ışığı ayarı
- Fényerősség beállító
- Pengaturan cahaya
- Nastavenie úrovne osvetlenia pre detekciu
- Nastavení úrovně osvětlení pro detekci
- مستوى الضبط ( نقطة مرجعية ل ضوء النهار )
- Setare prag luminos
- 조도 설정

	<ul style="list-style-type: none"> <li>• 10 - 1275 lux - Max.</li> <li>• 10 - 1275 lux - Máx.</li> <li>• 10 - 1275 лк - Макс.</li> <li>• 10 - 1275 lux - Maks.</li> <li>• 10 - 1275 lüks - Maks.</li> <li>• Max. 10 - 1275 lux</li> <li>• 10 - 1275 lux - Maksimum</li> <li>• 10 - 1275 lux - 최대</li> </ul>
	<ul style="list-style-type: none"> <li>• 10 sec - 10 min</li> <li>• 10 sec - 10 min</li> <li>• 10 c - 10 мин</li> <li>• 10 sek. - 10 min.</li> <li>• 10 sn. - 10 dk</li> <li>• 10 detik - 10 menit</li> <li>• من 10 ثواني الى 10 دقائق</li> <li>• 10 초 - 10 분</li> </ul>

	<ul style="list-style-type: none"> <li>• 8 m</li> <li>• 8 м</li> <li>• 8 meter</li> </ul>
<ul style="list-style-type: none"> <li>• Mode</li> <li>• Modo</li> <li>• Режим</li> <li>• Tryb</li> <li>• Mód</li> <li>• الوضع -اتوماتيكي</li> <li>• Mod</li> <li>• 모드</li> </ul>	<ul style="list-style-type: none"> <li>• Auto</li> <li>• авто</li> <li>• 자동</li> </ul>

- Potentiomètre de temporisation
- Regeling tijdsvertraging
- Timedelay
- Zeitverzögerung
- temporizador
- Ajuste da temporização
- Ρύθμιση του χρόνου
- Потенциометр регулировки выдержки времени
- Ustawienie zwłoki czasowej
- Gecikme süresi
- Időzítés beállító
- Pengaturan waktu jeda
- Nastavenie doby zopnutia
- Nastavení doby sepnutí
- مدة الانتظار -التأخير
- Setare temporizare
- 지연 시간

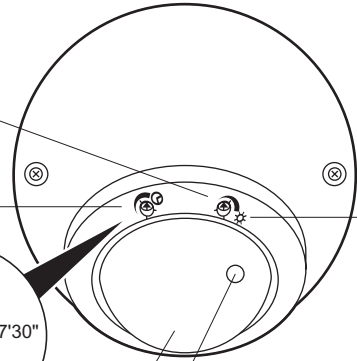
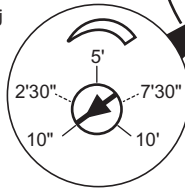

- 10 lux
- 10 лк
- 10 lüks
- 1275 lux
- 1275 лк
- 1275 lüks

- Max : Mode Test
- Max: Test Modus
- Max: Test Mode
- Max: Testmodus
- máx modo test
- Max : Modo Teste
- Макс.: режим проверки
- Maks: Tryb Testowy
- Maks: Test Modu
- Max: Teszt mód
- Maks: Mode Tes
- الحد الأقصى: وضع الاختبار
- Max: Mod Test
- 최대: 테스트 모드

- Capteur PIR
- Passieve infrarood sensor
- PIR sensor
- PIR-Sensor
- sensor PIR
- Lente de deteção IV
- Ανιχνευτής PIR
- Датчик PIR
- Czujka PIR
- PIR sensör
- IR érzékelő
- Sensor Passive Infra Red (PIR)
- PIR snímač
- PIR snímač
- PIR حساس
- Senzor PIR
- PIR (인체감지) 센서

- Cellule de luminosité
- Lichtsterkte sensor
- Daylight sensor
- Helligkeitssensor
- celula fotoelétrica
- Sensor de luminosidade
- Φωτοκύτταρο
- Датчик освещенности
- Czujka oświetlenia
- Gün ışığı sensörü
- Fényérzékelő
- Sensor cahaya
- Snímač intenzity denného osvetlenia
- Snímač intenzity denního osvětlení
- حساس ضوء النهار
- Senzor lumina
- 조도 센서